

### FEATURES

- 6A Peak Output Current
- Wide  $V_{IN}$  Supply Range: 5V to 25V
- Adjustable Gate Drive Voltage: 5V to 8V
- Logic Input can be Driven Below Ground
- 30ns Propagation Delay
- Supply Independent CMOS/TTL Input Thresholds
- Undervoltage Lockout
- Low Shutdown Current:  $<12\mu\text{A}$
- Overtemperature Protection
- Adjustable Blanking Time for MOSFET's Current Sense Signal (LTC4441)
- Available in SO-8 and 10-Lead MSOP (Exposed Pad) Packages

### APPLICATIONS

- Power Supplies
- Motor/Relay Control
- Line Drivers
- Charge Pumps

### DESCRIPTION

The LTC<sup>®</sup>4441/LTC4441-1 is an N-channel MOSFET gate driver that can supply up to 6A of peak output current. The chip is designed to operate with a supply voltage of up to 25V and has an adjustable linear regulator for the gate drive. The gate drive voltage can be programmed between 5V and 8V.

The LTC4441/LTC4441-1 features a logic threshold driver input. This input can be driven below ground or above the driver supply. A dual function control input is provided to disable the driver or to force the chip into shutdown mode with  $<12\mu\text{A}$  of supply current. Undervoltage lockout and overtemperature protection circuits will disable the driver output when activated. The LTC4441 also comes with an open-drain output that provides adjustable leading edge blanking to prevent ringing when sensing the source current of the power MOSFETs.

The LTC4441 is available in a thermally enhanced 10-lead MSOP package. The LTC4441-1 is the SO-8 version without the blanking function.

LT, LTC and LT are registered trademarks of Linear Technology Corporation. All other trademarks are the property of their respective owners. Protected by U.S. Patents including 6677210.

### TYPICAL APPLICATION

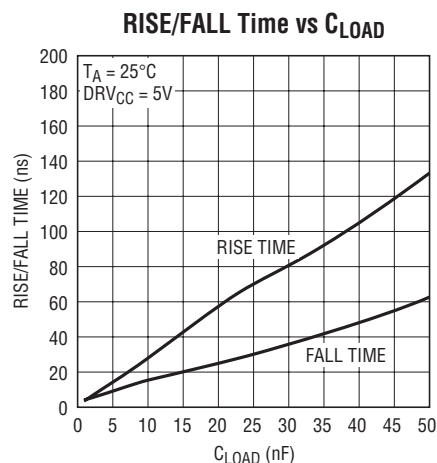
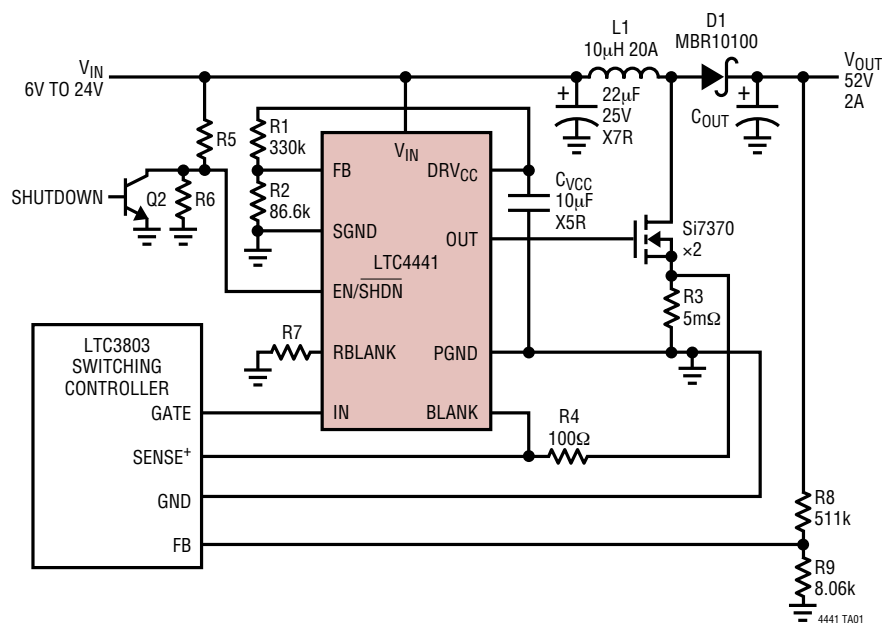

4441 TA01b

44411f

# LTC4441/LTC4441-1

## ABSOLUTE MAXIMUM RATINGS (Note 1)

Supply Voltage		RBLANK, BLANK (LTC4441 Only) .....	-0.3V to 5V
$V_{IN}$ .....	28V	OUT Output Current .....	100mA
$DRV_{CC}$ .....	9V	Operating Temperature Range (Note 2) ..	-40°C to 85°C
Input Voltage		Junction Temperature (Note 8) .....	125°C
IN .....	-15V to 15V	Storage Temperature Range .....	-65°C to 150°C
FB, EN/ $\overline{SHDN}$ .....	-0.3V to $DRV_{CC} + 0.3V$	Lead Temperature (Soldering, 10 sec) .....	300°C

## PACKAGE/ORDER INFORMATION

<p>MSE PACKAGE 10-LEAD PLASTIC MSOP <math>T_{JMAX} = 125^{\circ}C, \theta_{JA} = 38^{\circ}C/W</math> (NOTE 3) EXPOSED PAD (PIN 11) IS GND MUST BE SOLDERED TO PCB</p>	ORDER PART NUMBER	<p>S8 PACKAGE 8-LEAD PLASTIC SO <math>T_{JMAX} = 125^{\circ}C, \theta_{JA} = 150^{\circ}C/W</math></p>	ORDER PART NUMBER
	LTC4441EMSE LTC4441IMSE		LTC4441ES8-1 LTC4441IS8-1
	MSE PART MARKING		S8 PART MARKING
	LTBJQ LTBJP		44411 44411

Consult LTC Marketing for parts specified with wider operating temperature ranges.

## ELECTRICAL CHARACTERISTICS

The ● indicates specifications which apply over the full operating temperature range, otherwise specifications are at  $T_A = 25^{\circ}C$ .  $V_{IN} = 7.5V$ ,  $DRV_{CC} = 5V$ , unless otherwise specified.

SYMBOL	PARAMETER	CONDITIONS	MIN	TYP	MAX	UNITS	
$V_{DRVCC}$	Driver Supply Programmable Range		● 5		8	V	
$I_{VIN}$	$V_{IN}$ Supply Current	EN/ $\overline{SHDN}$ = 0V, IN = 0V	●	5	12	$\mu A$	
		EN/ $\overline{SHDN}$ = 5V, IN = 0V	●	250	500	$\mu A$	
		$f_{IN} = 100kHz, C_{OUT} = 4.7nF$ (Note 4)		3	6	mA	
<b><math>DRV_{CC}</math> Regulator</b>							
$V_{FB}$	Regulator Feedback Voltage	$V_{IN} = 7.5V$	●	1.11	1.21	1.31	V
$\Delta V_{DRVCC(LINE)}$	Regulator Line Regulation	$V_{IN} = 7.5V$ to 25V		9	40	mV	
$\Delta V_{DRVCC(LOAD)}$	Load Regulation	Load = 0mA to 40mA		-0.1		%	
$V_{DROPOUT}$	Regulator Dropout Voltage	Load = 40mA		370		mV	
$V_{UVLO}$	FB Pin UVLO Voltage	Rising Edge		1.09		V	
		Falling Edge		0.97		V	
<b>Input</b>							
$V_{IH}$	IN Pin High Input Threshold	Rising Edge	●	2	2.4	2.8	V
$V_{IL}$	IN Pin Low Input Threshold	Falling Edge	●	1	1.4	1.8	V
$V_{IH-V_{IL}}$	IN Pin Input Voltage Hysteresis	Rising-Falling Edge		1		V	
$I_{INP}$	IN Pin Input Current	$V_{IN} = \pm 10V$	●	$\pm 0.01$	$\pm 10$	$\mu A$	
$I_{EN/\overline{SHDN}}$	EN/ $\overline{SHDN}$ Pin Input Current	$V_{EN/\overline{SHDN}} = 9V$	●	$\pm 0.01$	$\pm 1$	$\mu A$	
$V_{SHDN}$	EN/ $\overline{SHDN}$ Pin Shutdown Threshold	Falling Edge		0.45		V	
$V_{EN}$	EN/ $\overline{SHDN}$ Pin Enable Threshold	Rising Edge		1.21		V	
		Falling Edge	●	1.036	1.09	1.145	V
$V_{EN(HYST)}$	EN/ $\overline{SHDN}$ Pin Enable Hysteresis	Rising-Falling Edge		0.12		V	

44411f

**ELECTRICAL CHARACTERISTICS** The ● indicates specifications which apply over the full operating temperature range, otherwise specifications are at  $T_A = 25^\circ\text{C}$ .  $V_{IN} = 7.5\text{V}$ ,  $\text{DRV}_{CC} = 5\text{V}$ , unless otherwise specified.

SYMBOL	PARAMETER	CONDITIONS	MIN	TYP	MAX	UNITS
<b>Output</b>						
$R_{ONL}$	Driver Output Pull-Down Resistance	$I_{OUT} = 100\text{mA}$	●	0.35	0.8	$\Omega$
$I_{PU}$	Driver Output Peak Pull-Up Current	$\text{DRV}_{CC} = 8\text{V}$		6		A
$I_{PD}$	Driver Output Peak Pull-Down Current	$\text{DRV}_{CC} = 8\text{V}$		6		A
$R_{ON(BLANK)}$	BLANK Pin Pull-Down Resistance	$I_N = 0\text{V}$ , $I_{BLANK} = 100\text{mA}$ LTC4441 Only		11		$\Omega$
$V_{RBLANK}$	RBLANK Pin Voltage	$R_{BLANK} = 200\text{k}\Omega$ LTC4441 Only		1.3		V

**Switching Timing**

$t_{PHL}$	Driver Output High-Low Propagation Delay	$C_{OUT} = 4.7\text{nF}$ (Note 5)		30		ns
$t_{PLH}$	Driver Output Low-High Propagation Delay	$C_{OUT} = 4.7\text{nF}$ (Note 5)		36		ns
$t_r$	Driver Output Rise Time	$C_{OUT} = 4.7\text{nF}$ (Note 5)		13		ns
$t_f$	Driver Output Fall Time	$C_{OUT} = 4.7\text{nF}$ (Note 5)		8		ns
$t_{BLANK}$	Driver Output High to BLANK Pin High	$R_{BLANK} = 200\text{k}\Omega$ (Note 6)		200		ns

**Note 1:** Absolute Maximum Ratings are those values beyond which the life of a device may be impaired.

**Note 2:** The LTC4441E/LTC4441E-1 are guaranteed to meet performance specifications from  $0^\circ\text{C}$  to  $70^\circ\text{C}$ . Specifications over the  $-40^\circ\text{C}$  to  $85^\circ\text{C}$  operating temperature range are assured by design, characterization and correlation with statistical process controls. The LTC4441/LTC4441-1 are guaranteed and tested over the  $-40^\circ\text{C}$  to  $85^\circ\text{C}$  operating temperature range.

**Note 3:** Failure to solder the Exposed Pad of the MSE package to the PC board will result in a thermal resistance much higher than  $38^\circ\text{C/W}$ .

**Note 4:** Supply current in normal operation is dominated by the current needed to charge and discharge the external power MOSFET gate. This

current will vary with supply voltage, switching frequency and the external MOSFETs used.

**Note 5:** Rise and fall times are measured using 10% and 90% levels. Delay times are measured from 50% of input to 20%/80% levels at driver output.

**Note 6:** Blanking time is measured from 50% of OUT leading edge to 10% of BLANK with a  $1\text{k}\Omega$  pull-up at BLANK pin. LTC4441 only.

**Note 7:** Guaranteed by design, not subject to test.

**Note 8:** This IC includes overtemperature protection that is intended to protect the device during momentary overload conditions. The junction temperature will exceed  $125^\circ\text{C}$  when overtemperature protection is active. Continuous operation above the maximum operating junction temperature may impair device reliability.

**TYPICAL PERFORMANCE CHARACTERISTICS**

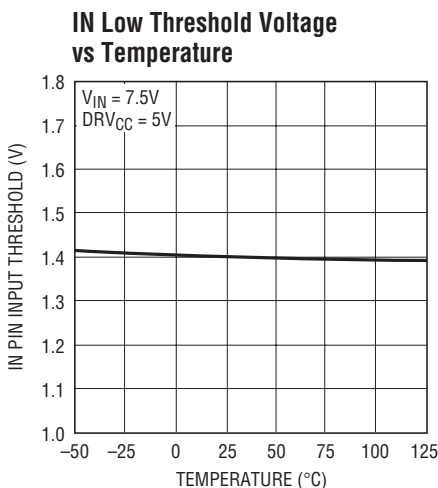

4441 G01

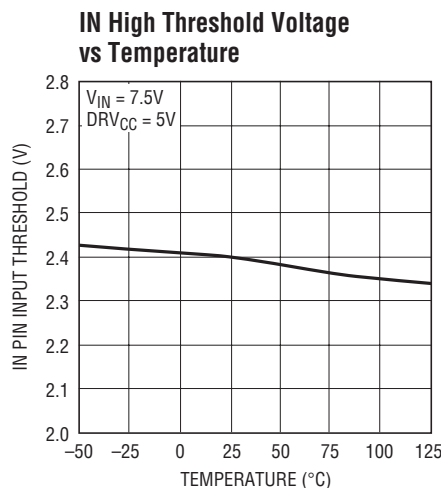

4441 G02

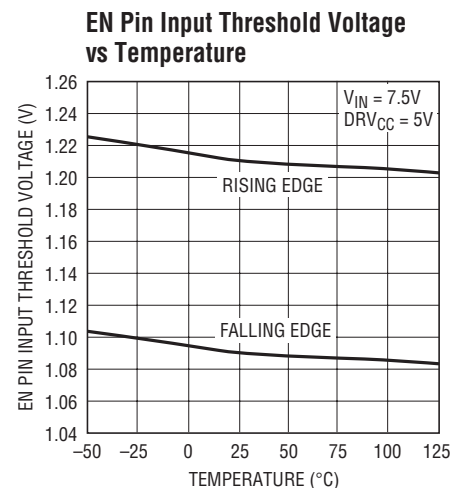

4441 G03

44411f

## TYPICAL PERFORMANCE CHARACTERISTICS

**FB Pin UVLO Threshold vs Temperature**

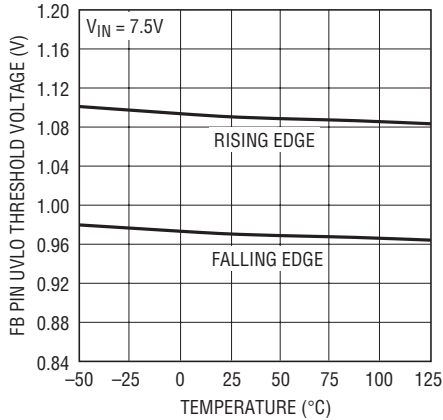

**SD Pin Input Threshold Voltage vs Temperature**

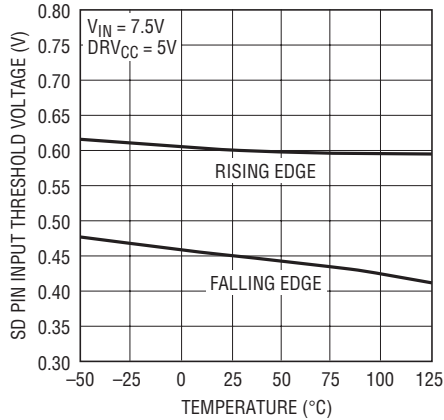

**DRVCC Voltage vs Temperature**

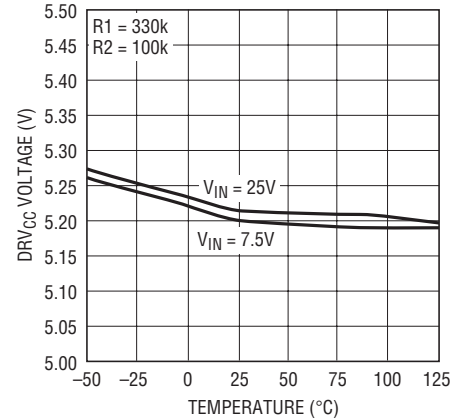

**DRVCC Load Regulation**

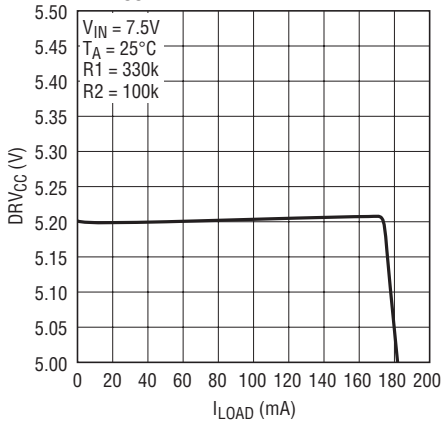

**DRVCC Line Regulation**

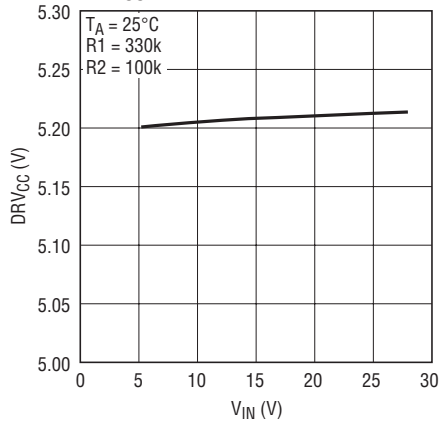

**DRVCC Dropout Voltage vs Temperature**

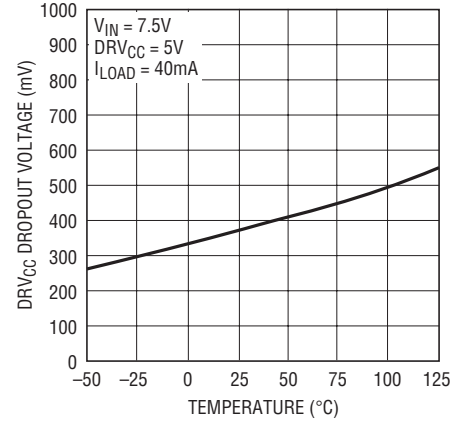

**OUT Pin Pull-Down Resistance vs Temperature**

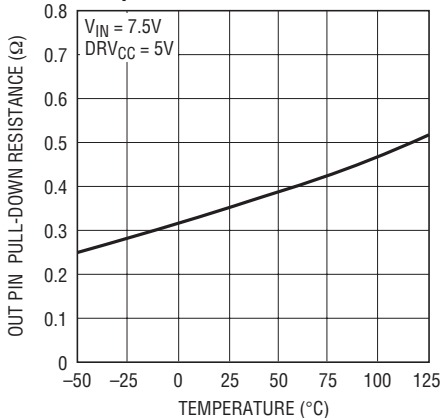

**tPLH, tPHL vs DRVCC**

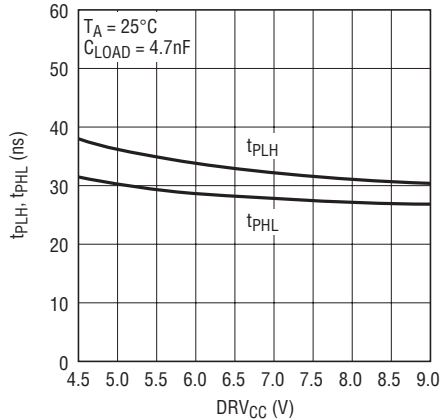

**tPLH, tPHL vs Temperature**

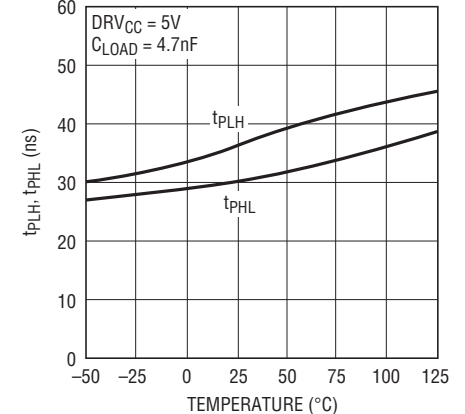

# TYPICAL PERFORMANCE CHARACTERISTICS

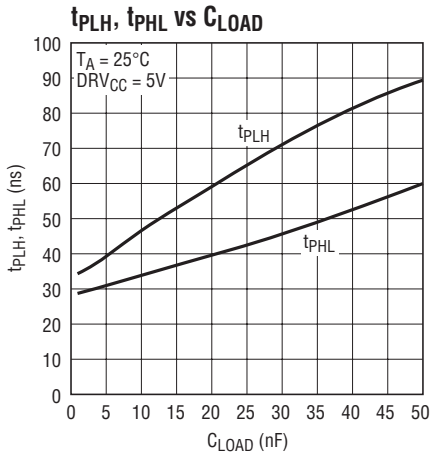

4441 G13

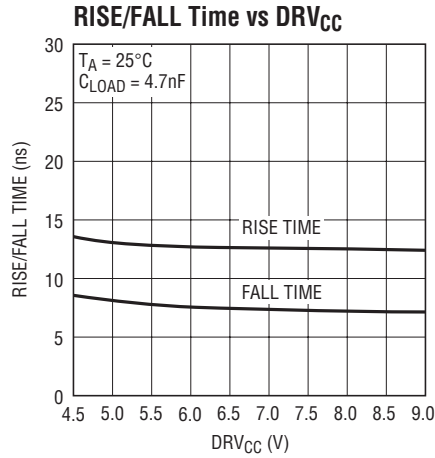

4441 G14

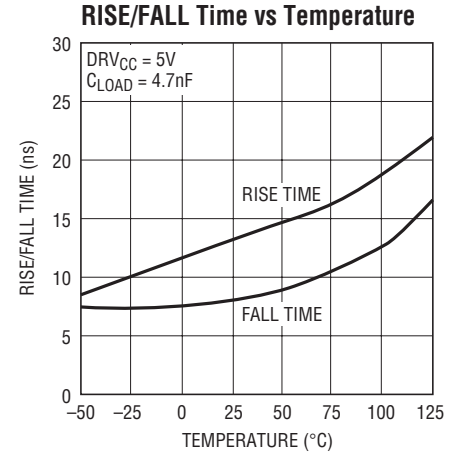

4441 G15

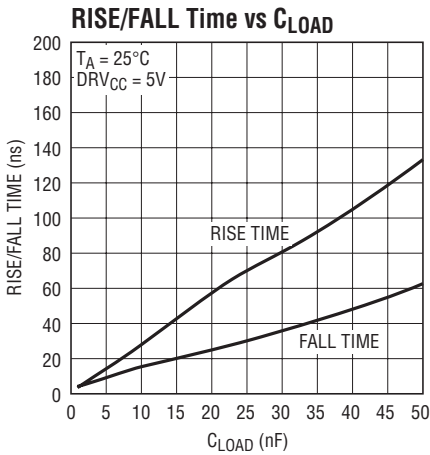

4441 G16

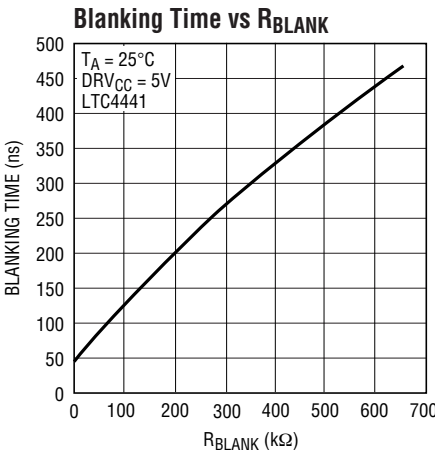

4441 G17

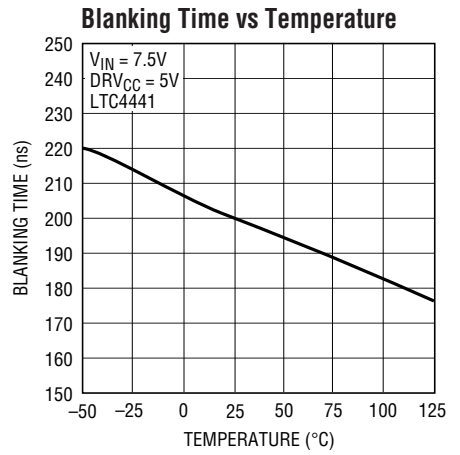

4441 G18

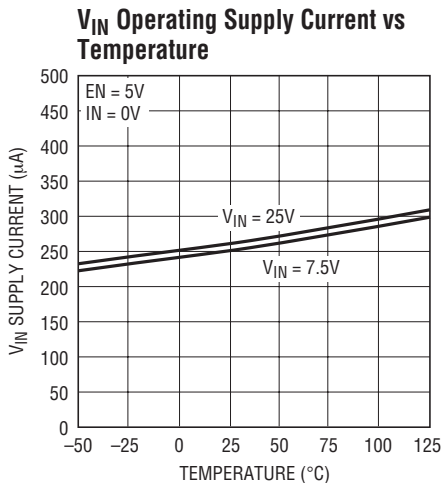

4441 G19

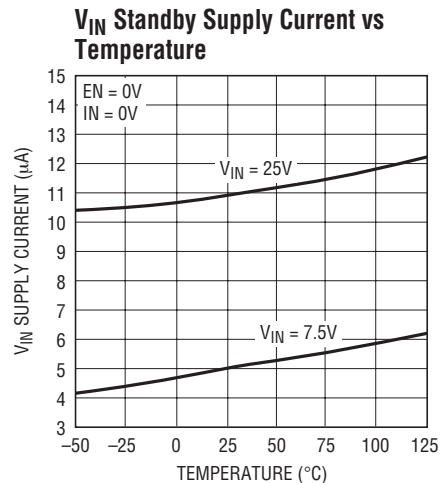

4441 G20

## TYPICAL PERFORMANCE CHARACTERISTICS

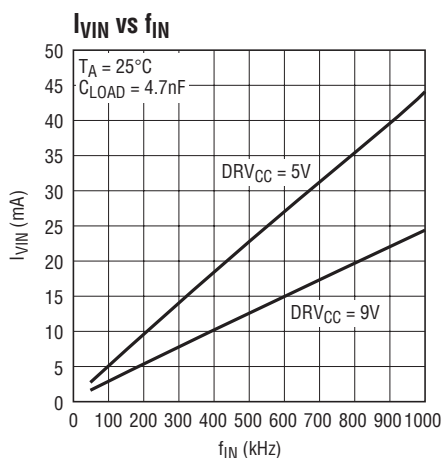

4441 G21

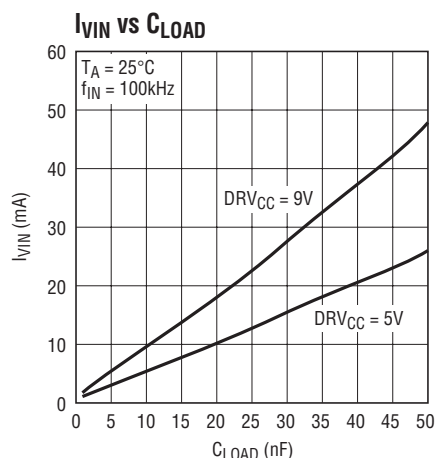

4441 G22

## PIN FUNCTIONS MSOP/SO-8

**PGND (Pin 1/Pin 1):** Driver Ground. Connect the DRV<sub>CC</sub> bypass capacitor directly to this pin, as close as possible to the IC. In addition, connect the PGND and SGND pins together close to the IC, and then connect this node to the source of the power MOSFET (or current sense resistor) with as short and wide a PCB trace as possible.

**BLANK (Pin 2/NA):** Current Sense Blanking Output. Use this pin to assert a blanking time in the power MOSFET's source current sense signal. The LTC4441 pulls this open-drain output to SGND if the driver output is low. The output becomes high impedance after a programmable blanking time from the driver leading edge output. This blanking time can be adjusted with the RBLANK pin.\*

**RBLANK (Pin 3/NA):** Blanking Time Adjust Input. Connect a resistor from this pin to SGND to set the blanking time. A small resistor value gives a shorter delay. Leave this pin floating if the BLANK pin is not used.\*

**SGND (Pin 4/Pin 2):** Signal Ground. Ground return for the DRV<sub>CC</sub> regulator and low power circuitry.

**IN (Pin 5/Pin 3):** Driver Logic Input. This is the non-inverting driver input under normal operating conditions.

\*Available only on the lo-lead version of the LTC4441.

**EN/SHDN (Pin 6/Pin 4):** Enable/Shutdown Input. Pulling this pin above 1.21V allows the driver to switch. Pulling this pin below 1.09V forces the driver output to go low. Pulling this pin below 0.45V forces the LTC4441/LTC4441-1 into shutdown mode; the DRV<sub>CC</sub> regulator turns off and the supply current drops below 12 $\mu$ A.

**FB (Pin 7/Pin 5):** DRV<sub>CC</sub> Regulator Feedback Input. Connect this pin to the center tap of an external resistive divider between DRV<sub>CC</sub> and SGND to program the DRV<sub>CC</sub> regulator output voltage. To ensure loop stability, use the value of 330k $\Omega$  for the top resistor, R1.

**V<sub>IN</sub> (Pin 8/Pin 6):** Main Supply Input. This pin powers the DRV<sub>CC</sub> linear regulator. Bypass this pin to SGND with a 1 $\mu$ F ceramic, tantalum or other low ESR capacitor in close proximity to the LTC4441/LTC4441-1.

**DRV<sub>CC</sub> (Pin 9/Pin 7):** Linear Regulator Output. This output pin powers the driver and the control circuitry. Bypass this pin to PGND using a 10 $\mu$ F ceramic, low ESR (X5R or X7R) capacitor in close proximity to the LTC4441/LTC4441-1.

**OUT (Pin 10/Pin 8):** Driver Output.

**Exposed Pad (Pin 11/NA):** Ground. The Exposed Pad must be soldered to the PCB ground.

## BLOCK DIAGRAM

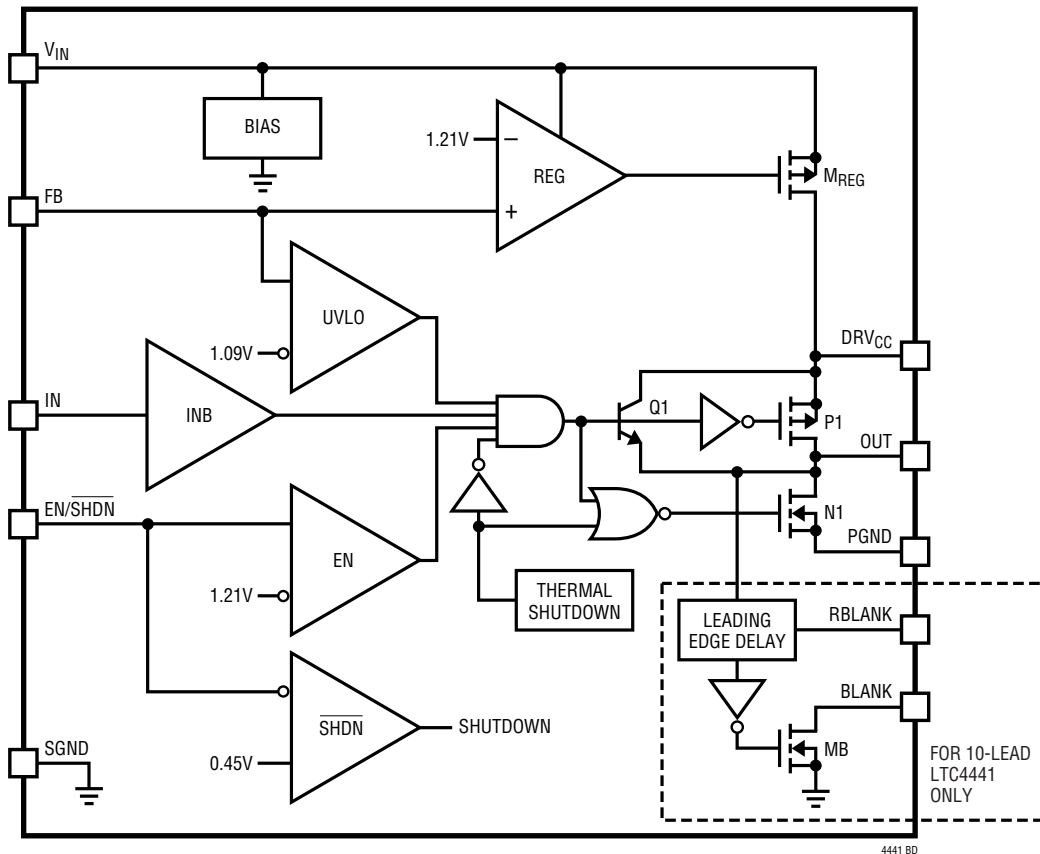

## APPLICATIONS INFORMATION

### Overview

Power MOSFETs generally account for the majority of power lost in a converter. It is important to choose not only the type of MOSFET used, but also its gate drive circuitry. The LTC4441/LTC4441-1 is designed to drive an N-channel power MOSFET with little efficiency loss. The LTC4441/LTC4441-1 can deliver up to 6A of peak current using a combined NPN Bipolar and MOSFET output stage. This helps to turn the power MOSFET fully “on” or “off” with a very brief transition region.

The LTC4441/LTC4441-1 includes a programmable linear regulator to regulate the gate drive voltage. This regulator

provides the flexibility to use either standard threshold or logic level MOSFETs.

### DRV<sub>CC</sub> Regulator

An internal, P-channel low dropout linear regulator provides the DRV<sub>CC</sub> supply to power the driver and the pre-driver logic circuitry as shown in Figure 1. The regulator output voltage can be programmed between 5V and 8V with an external resistive divider between DRV<sub>CC</sub> and SGND and a center tap connected to the FB pin. The regulator needs an R1 value of around 330k to ensure loop





## APPLICATIONS INFORMATION

inductor or resistor). The slew rate of the drain voltage causes current to flow to the MOSFET's gate through its gate-to-drain capacitance. If the MOSFET driver does not have sufficient sink current capability (low output impedance), the current through the power MOSFET's  $C_{GD}$  can momentarily pull the gate high and turn the MOSFET back on.

A similar situation occurs during power-up when  $V_{IN}$  is ramping up with the  $DRV_{CC}$  regulator output still low. N1 is off and the driver output, OUT, may momentarily pull high through the power MOSFET's  $C_{GD}$ , turning on the power MOSFET. The N-channel MOSFETs N2 and N3, shown in Figure 2, prevent the driver output from going high in this situation. If  $DRV_{CC}$  is low, N3 is off. If OUT is pulled high through the power MOSFET's  $C_{GD}$ , the gate of N2 gets pulled high through  $R_D$ . This turns N2 on, which then pulls OUT low. Once  $DRV_{CC}$  is  $>1V$ , N3 turns on to hold the N2 gate low, thus disabling N2.

The predriver that drives Q1, P1 and N1 uses an adaptive method to minimize cross-conduction currents. This is done with a 5ns nonoverlapping transition time. N1 is fully turned off before Q1 is turned on and vice-versa using this 5ns buffer time. This minimizes any cross-conduction currents while Q1 and N1 are switching on and off without affecting their rise and fall times.

### Thermal Shutdown

The LTC4441/LTC4441-1 has a thermal detector that disables the  $DRV_{CC}$  regulator and pulls the driver output low when activated. If the junction temperature exceeds  $150^{\circ}C$ , the driver pull-up devices, Q1 and P1, turn off while the pull-down device, N1, turns on briskly for 200ns to quickly pull the output low. The thermal shutdown circuit has  $20^{\circ}C$  of hysteresis.

### Enable/Shutdown Input

The EN/SHDN pin serves two functions. Pulling this pin below  $0.45V$  forces the LTC4441/LTC4441-1 into shutdown mode. In shutdown mode, the internal circuitry and the  $DRV_{CC}$  regulator are off and the supply current drops to  $<12\mu A$ . If the input voltage is between  $0.45V$  and  $1.21V$ , the  $DRV_{CC}$  regulator and internal circuit power up but the driver output stays low. If the input goes above  $1.21V$ , the

driver starts switching according to the input logic signal. The driver enable comparator has a small hysteresis of  $120mV$ .

### Blanking

In some switcher applications, a current sense resistor is placed between the low side power MOSFET's source terminal and ground to sense the current in the MOSFET. With this configuration, the switching controller must incorporate some timing interval to blank the ringing on the current sense signal immediately after the MOSFET is turned on. This ringing is caused by the parasitic inductance and capacitance of the PCB trace and the MOSFET. The duration of the ringing is thus dependent on the PCB layout and the components used and can be longer than the blanking interval provided by the controller.

The 10-Lead LTC4441 includes an open-drain output that can be used to extend this blanking interval. The 8-Lead LTC4441-1 does not have this blanking function. Figure 3 shows the BLANK pin connection. The BLANK pin is connected directly to the switching controller's SENSE+ input. Figure 4 shows the blanking waveforms. If the driver input is low, the external power MOSFET is off and MB turns on to hold SENSE+ low. If the driver input goes high, the power MOSFET turns on after the driver's propagation delay. MB remains on, attenuating the ringing seen by the controller's SENSE+ input. After the programmed blanking time, MB turns off to enable the current sense

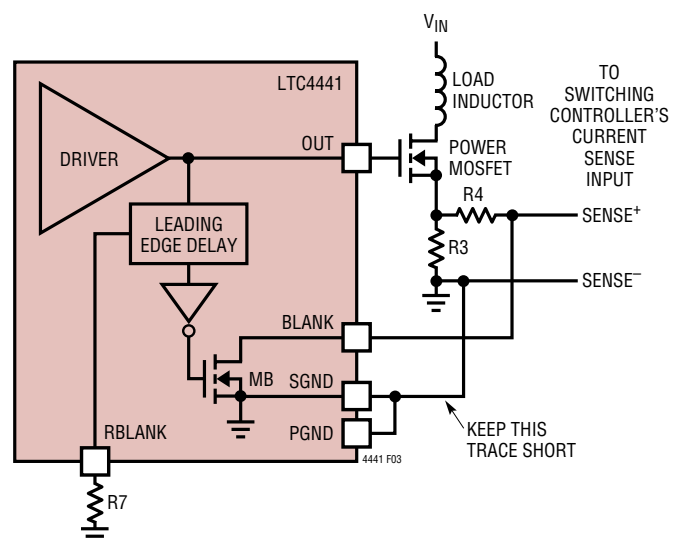
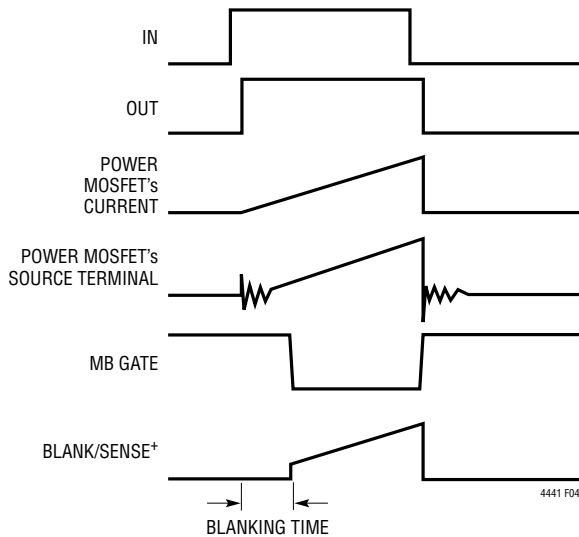

Figure 3. Blanking Circuit

## APPLICATIONS INFORMATION



**Figure 4. Blanking Waveforms**

signal. MB is designed to turn on and turn off at a controlled slew rate. This is to prevent the gate switching noise from coupling into the current sense signal.

The blanking interval can be adjusted using resistor R7 connected to the RBLANK pin. A small resistance value gives a shorter interval with a default minimum of 75ns.

The value of the resistor R4 and the on-resistance of MB (typically 11Ω) form a resistive divider attenuating the ringing. R4 needs to be large for effective blanking, but not so large as to cause delay to the sense signal. A resistance value of 1k to 10k is recommended.

For optimum performance, the LTC4441/LTC4441-1 should be placed as close as possible to the power MOSFET and current sense resistor, R3.

### Power Dissipation

To ensure proper operation and long-term reliability, the LTC4441/LTC4441-1 must not operate beyond its maximum temperature rating. The junction temperature can be calculated by:

$$I_{Q(TOT)} = I_Q + f \cdot Q_G$$

$$P_D = V_{IN} \cdot (I_Q + f \cdot Q_G)$$

$$T_J = T_A + P_D \cdot \theta_{JA}$$

where:

$I_Q$  = LTC4441/LTC4441-1 static quiescent current, typically 250μA

$f$  = Logic input switching frequency

$Q_G$  = Power MOSFET total gate charge at corresponding  $V_{GS}$  voltage equal to  $DRV_{CC}$

$V_{IN}$  = LTC4441/LTC4441-1 input supply voltage

$T_J$  = Junction temperature

$T_A$  = Ambient temperature

$\theta_{JA}$  = Junction-to-ambient thermal resistance. The 10-pin MSOP package has a thermal resistance of  $\theta_{JA} = 38^\circ\text{C}/\text{W}$ .

The total supply current,  $I_{Q(TOT)}$ , consists of the LTC4441/LTC4441-1's static quiescent current,  $I_Q$ , and the current required to drive the gate of the power MOSFET, with the latter usually much higher than the former. The dissipated power,  $P_D$ , includes the efficiency loss of the  $DRV_{CC}$  regulator. With a programmed  $DRV_{CC}$ , a high  $V_{IN}$  results in higher efficiency loss.

As an example, consider an application with  $V_{IN} = 12\text{V}$ . The switching frequency is 300kHz and the maximum ambient temperature is 70°C. The power MOSFET chosen is three pieces of IRFB31N20D, which has a maximum  $R_{DS(ON)}$  of 82mΩ (at room temperature) and a typical total gate charge of 70nC (the temperature coefficient of the gate charge is low).

$$I_{Q(TOT)} = 500\mu\text{A} + 210\text{nC} \cdot 300\text{kHz} = 63.5\text{mA}$$

$$P_{IC} = 12\text{V} \cdot 63.5\text{mA} = 0.762\text{W}$$

$$T_J = 70^\circ\text{C} + 38^\circ\text{C}/\text{W} \cdot 0.762\text{W} = 99^\circ\text{C}$$

This demonstrates how significant the gate charge current can be when compared to the LTC4441/LTC4441-1's static quiescent current. To prevent the maximum junction temperature from being exceeded, the input supply current must be checked when switching at high  $V_{IN}$ . A tradeoff between the operating frequency and the size of the power MOSFET may be necessary to maintain a reliable LTC4441/LTC4441-1 junction temperature. Prior to lowering the operating frequency, however, be sure to

## APPLICATIONS INFORMATION

check with power MOSFET manufacturers for their innovations on low  $Q_G$ , low  $R_{DS(ON)}$  devices. Power MOSFET manufacturing technologies are continually improving, with newer and better performing devices being introduced.

### PC Board Layout Checklist

When laying out the printed circuit board, the following checklist should be used to ensure proper operation of the LTC4441/LTC4441-1:

A. Mount the bypass capacitors as close as possible between the  $DRV_{CC}$  and PGND pins and between the  $V_{IN}$  and SGND pins. The PCB trace loop areas should be tightened as much as possible to reduce inductance.

B. Use a low inductance, low impedance ground plane to reduce any ground drop. Remember that the LTC4441/LTC4441-1 switches 6A peak current and any significant ground drop will degrade signal integrity.

C. Keep the PCB ground trace between the LTC4441/LTC4441-1 ground pins (PGND and SGND) and the external current sense resistor as short and wide as possible.

D. Plan the ground routing carefully. Know where the large load switching current paths are. Maintain separate ground return paths for the input pin and output pin to avoid sharing small-signal ground with large load ground return. Terminate these two ground traces only at the GND pin of the driver (STAR network).

E. Keep the copper trace between the driver output pin and the load short and wide.

F. Place the small-signal components away from the high frequency switching nodes. These components include the resistive networks connected to the FB, RBLANK and EN/SHDN pins.

## PACKAGE DESCRIPTION

**MSE Package**  
**10-Lead Plastic MSOP**  
(Reference LTC DWG # 05-08-1663)

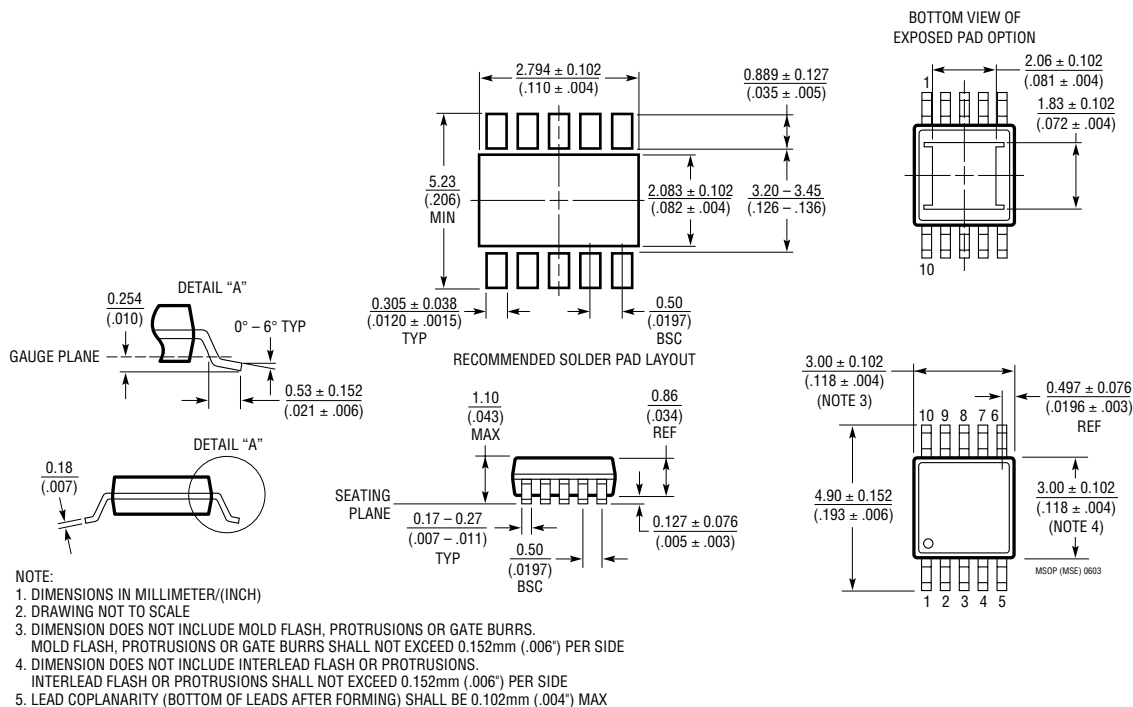

# PACKAGE DESCRIPTION

## S8 Package 8-Lead Plastic Small Outline (Narrow .150 Inch) (Reference LTC DWG # 05-08-1610)

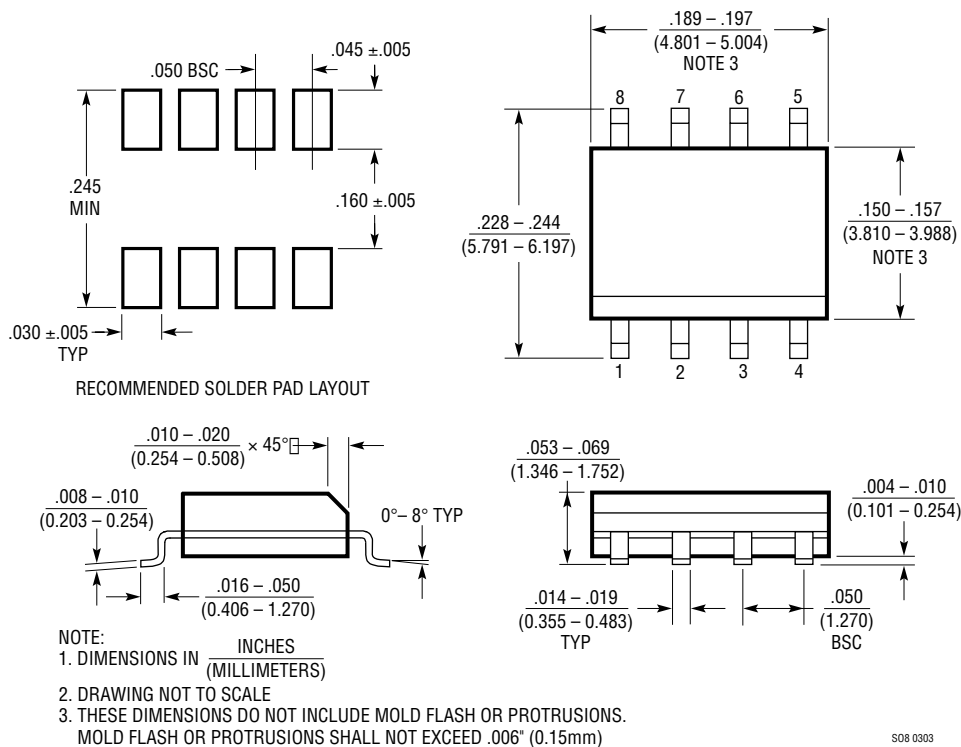

## RELATED PARTS

PART NUMBER	DESCRIPTION	COMMENTS
LTC1154	High Side Micropower MOSFET Driver	Internal Charge Pump, 4.5V to 48V Supply Range
LTC1155	Dual Micropower High/Low Side Driver	Internal Charge Pump, 4.5V to 18V Supply Range
LT <sup>®</sup> 1161	Quad Protected High Side MOSFET Driver	8V to 48V Supply Range, $t_{ON} = 200ms$ , $t_{OFF} = 28ms$
LTC1163	Triple 1.8V to 6V High Side MOSFET Driver	1.8V to 48V Supply Range, $t_{ON} = 95ms$ , $t_{OFF} = 45ms$
LTC1693	High Speed Single/Dual N-Channel MOSFET Driver	CMOS Compatible Input, $V_{CC}$ Range: 4.5V to 12V
LTC3900	Synchronous Rectifier Driver for Forward Converter	Pulse Transformer Synchronization Input
LTC3901	Secondary Side Synchronous Driver for Push-Pull and Full-Bridge Converter	Gate Drive Transformer Synchronous Input
LTC4440	High Speed, High Voltage, High Side Gate Driver	Wide Operating $V_{IN}$ Range: Up to 80V DC, 100V Transient